

Description

The 6P10 uses advanced trench technology and design to provide excellent $R_{DS(ON)}$ with low gate charge. It can be used in a wide variety of applications. It is ESD protected.

General Features

V_{DSS}	$R_{DS(ON)}$ @ -10V (typ)	$R_{DS(ON)}$ @ -4.5V (typ)	I_D
-100V	180m Ω	200m Ω	-6A

- Super high dense cell design
- Advanced trench process technology
- Reliable and rugged
- High density cell design for ultra low on-resistance
- RoHS Compliant

Application

- Power switch
- DC/DC converters

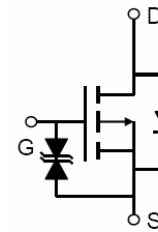

Schematic diagram

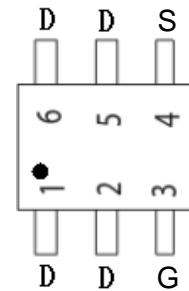

Marking and pin assignment

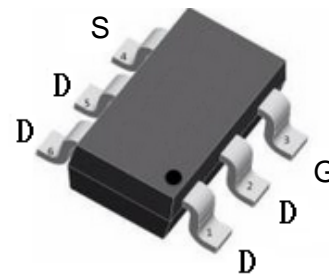

SOT-23-6L

Ordering Information

Part Number	Marking	Case	Packaging
6P10	6P10	SOT-23-6L	3000pcs/Reel

Absolute Maximum Ratings ($T_A=25^\circ\text{C}$ unless otherwise noted)

Parameter	Symbol	Limit	Unit
Drain-Source Voltage	V_{DS}	-100	V
Gate-Source Voltage	V_{GS}	± 20	V
Drain Current-Continuous	I_D	-6	A
Drain Current-Continuous($T_A=75^\circ\text{C}$)	$I_D(75^\circ\text{C})$	-4.3	A
Pulsed Drain Current	I_{DM}	-30	A
Maximum Power Dissipation	P_D	1.25	W
Single pulse avalanche energy ^(Note 5)	E_{AS}	60	mJ
Operating Junction and Storage Temperature Range	T_J, T_{STG}	-55 To 150	$^\circ\text{C}$

Thermal Characteristic

Thermal Resistance, Junction-to-Ambient	$R_{\theta JA}$	100	$^{\circ}C/W$
---	-----------------	-----	---------------

Electrical Characteristics ($T_A=25^{\circ}C$ unless otherwise noted)

Parameter	Symbol	Condition	Min	Typ	Max	Unit
Off Characteristics						
Drain-Source Breakdown Voltage	BV_{DSS}	$V_{GS}=0V, I_D=-250\mu A$	-100	-	-	V
Zero Gate Voltage Drain Current	I_{DSS}	$V_{DS}=-100V, V_{GS}=0V$	-	-	1	μA
Gate-Body Leakage Current	I_{GSS}	$V_{GS}=\pm 16V, V_{DS}=0V$	-	-	± 10	μA
On Characteristics (Note 3)						
Gate Threshold Voltage	$V_{GS(th)}$	$V_{DS}=V_{GS}, I_D=-250\mu A$	-1.2	-1.75	-2.8	V
Drain-Source On-State Resistance	$R_{DS(ON)}$	$V_{GS}=-10V, I_D=-6A$	-	180	205	m Ω
Drain-Source On-State Resistance	$R_{DS(ON)}$	$V_{GS}=-4.5V, I_D=-6A$	-	200	250	m Ω
Forward Transconductance	g_{FS}	$V_{DS}=-15V, I_D=-5A$	10	-	-	S
Dynamic Characteristics (Note 4)						
Input Capacitance	C_{iss}	$V_{DS}=-25V, V_{GS}=0V,$ $F=1.0MHz$	-	760	-	PF
Output Capacitance	C_{oss}		-	260	-	PF
Reverse Transfer Capacitance	C_{rss}		-	170	-	PF
Switching Characteristics (Note 4)						
Turn-on Delay Time	$t_{d(on)}$	$V_{DD}=-50V, I_D=-6A$ $V_{GS}=-10V, R_{GEN}=9.1\Omega$	-	14	-	nS
Turn-on Rise Time	t_r		-	18	-	nS
Turn-Off Delay Time	$t_{d(off)}$		-	50	-	nS
Turn-Off Fall Time	t_f		-	18	-	nS
Total Gate Charge	Q_g	$V_{DS}=-50V, I_D=-6A,$ $V_{GS}=-10V$	-	25	-	nC
Gate-Source Charge	Q_{gs}		-	5	-	nC
Gate-Drain Charge	Q_{gd}		-	7	-	nC
Drain-Source Diode Characteristics						
Diode Forward Voltage	V_{SD}	$V_{GS}=0V, I_S=-6A$	-	-	-1.2	V
Diode Forward Current	I_S	-	-	-	-13	A
Reverse Recovery Time	t_{rr}	$T_J = 25^{\circ}C, I_F = -6A$ $di/dt = 100A/\mu s$ (Note 3)	-	35	-	nS
Reverse Recovery Charge	Q_{rr}		-	46	-	nC
Forward Turn-On Time	t_{on}	Intrinsic turn-on time is negligible (turn-on is dominated by LS+LD)				

Notes:

1. Repetitive Rating: Pulse width limited by maximum junction temperature.
2. Surface Mounted on FR4 Board, $t \leq 10$ sec.
3. Pulse Test: Pulse Width $\leq 300\mu s$, Duty Cycle $\leq 2\%$.
4. Guaranteed by design, not subject to production
5. E_{AS} condition: $T_J=25^{\circ}C, V_{DD}=-50V, V_G=-10V, L=0.5mH, R_g=25\Omega$

Test Circuit

1) E_{AS} Test Circuit

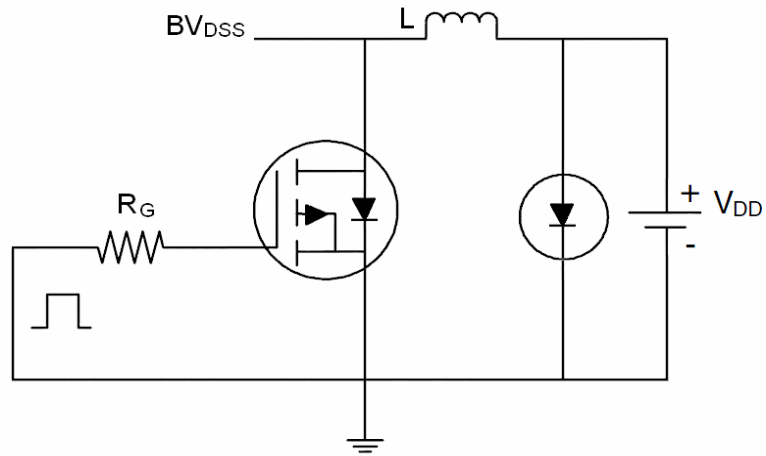

2) Gate Charge Test Circuit

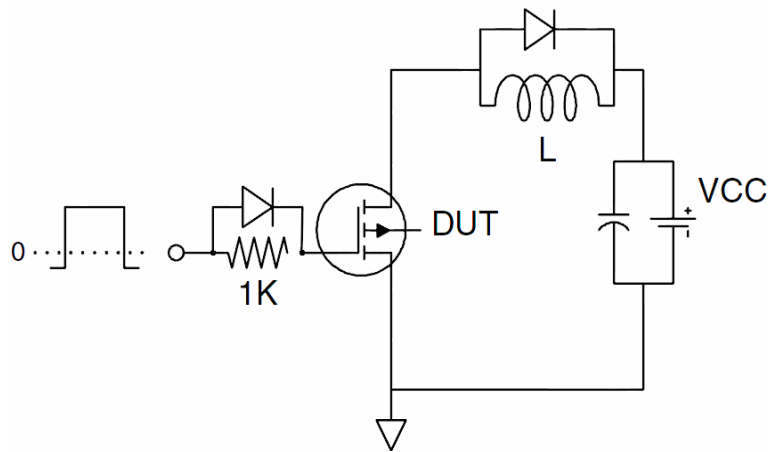

3) Switch Time Test Circuit

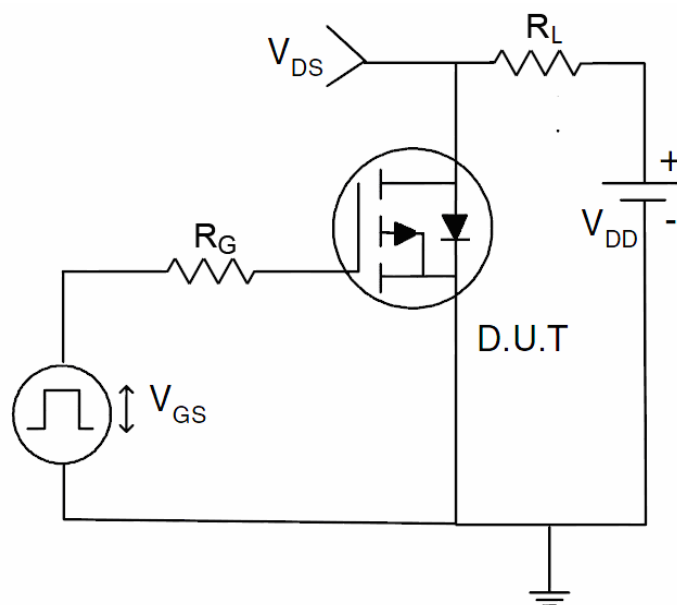

Typical Electrical and Thermal Characteristics (Curves)

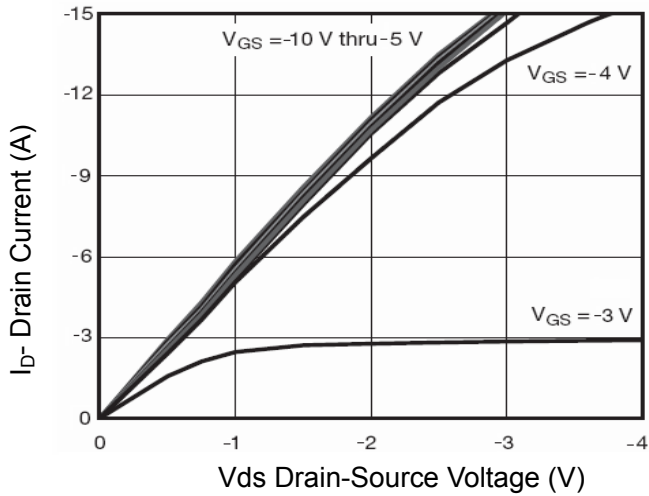

Figure 1 Output Characteristics

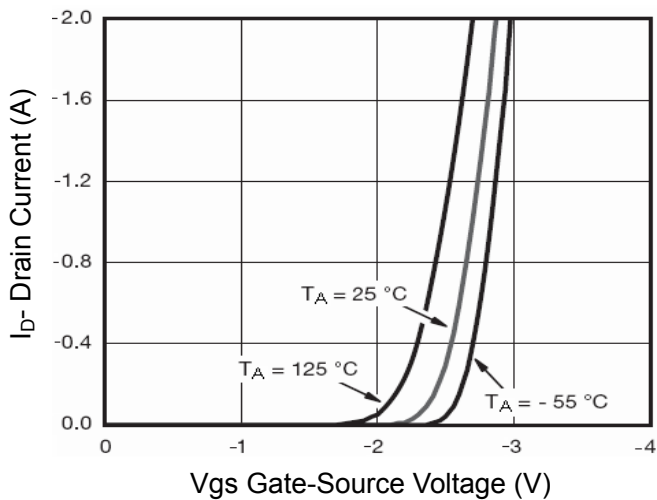

Figure 2 Transfer Characteristics

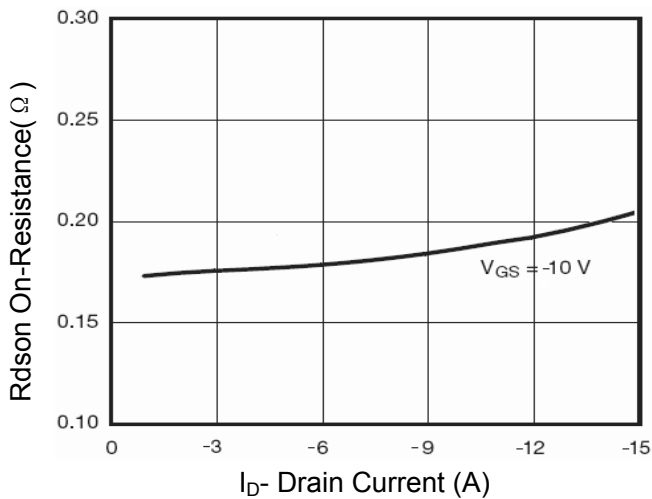

Figure 3 Rdson- Drain Current

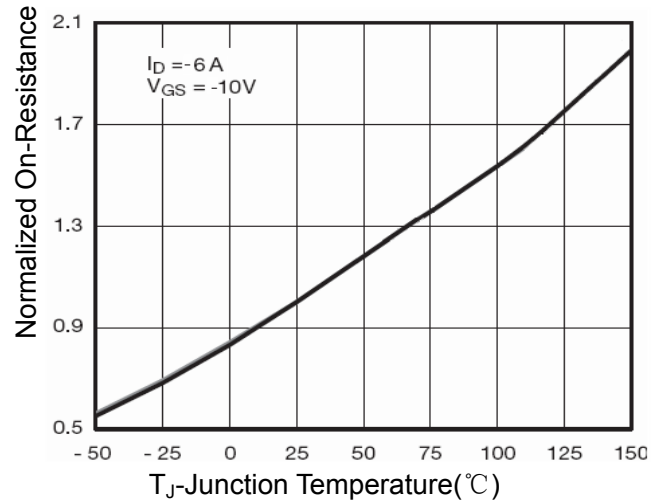

Figure 4 Rdson-Junction Temperature

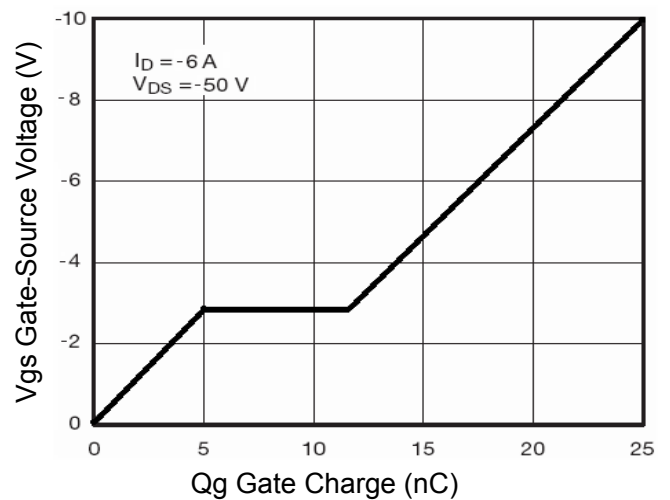

Figure 5 Gate Charge

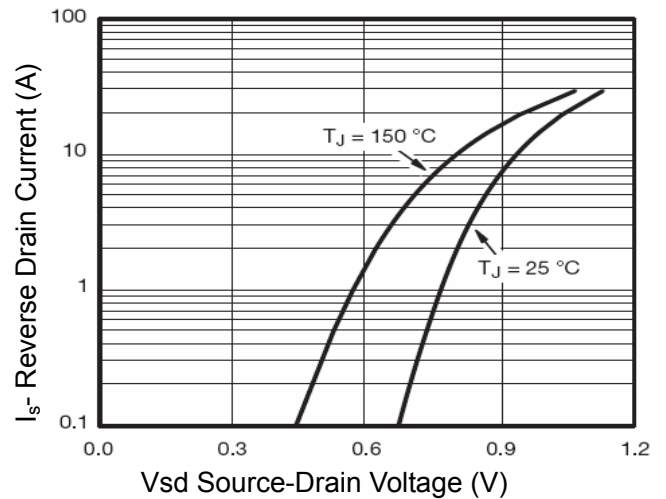

Figure 6 Source- Drain Diode Forward

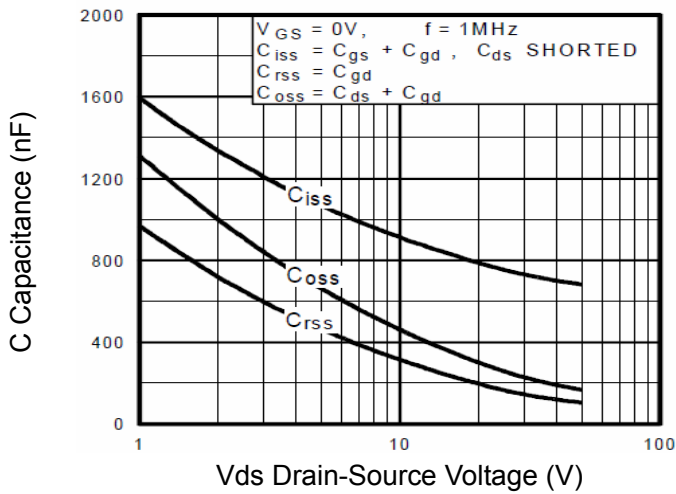

Figure 7 Capacitance vs Vds

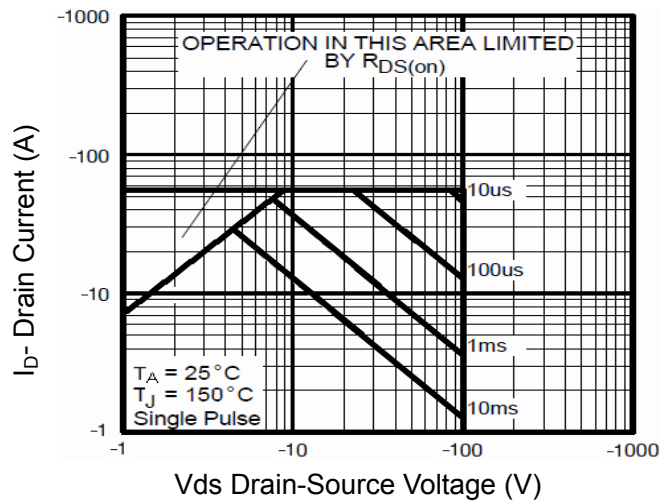

Figure 8 Safe Operation Area

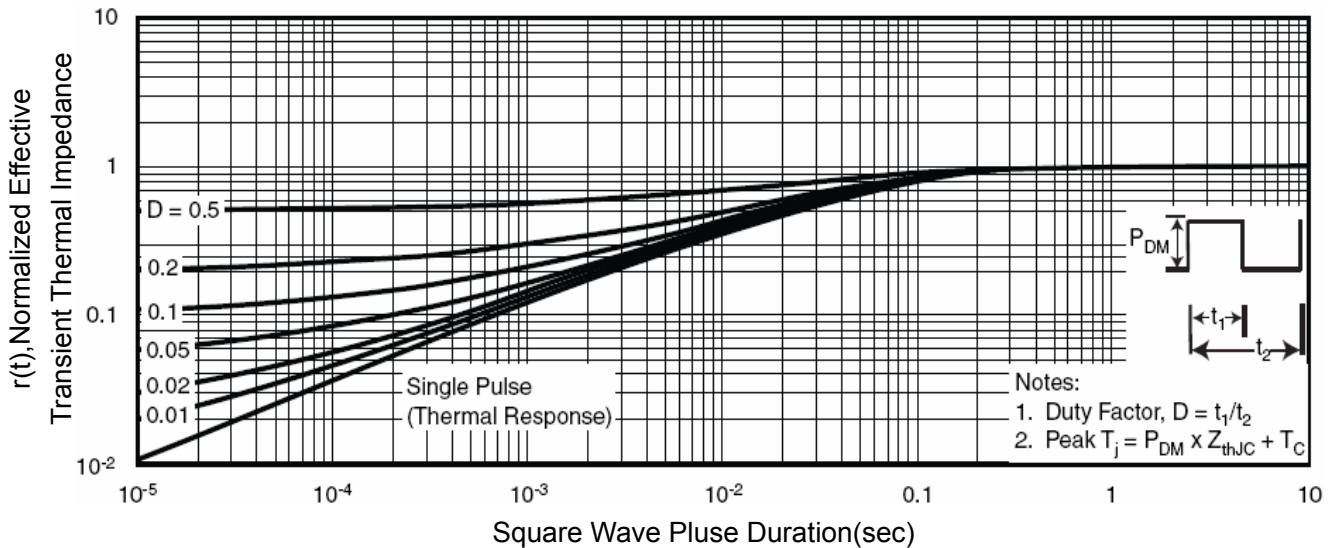
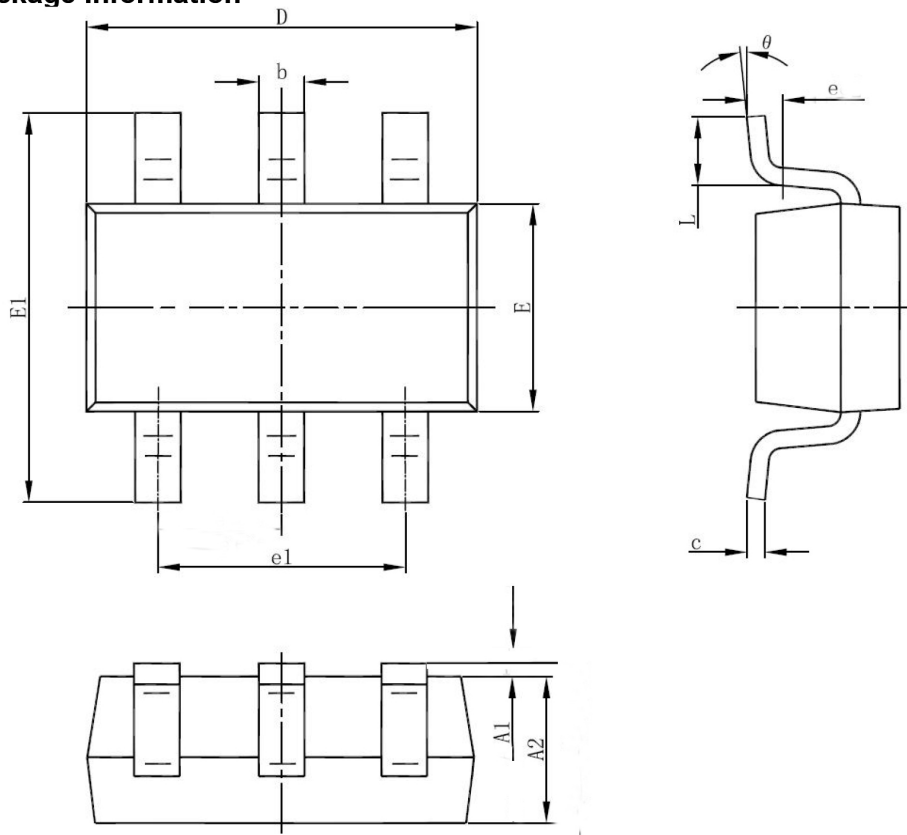

Figure 9 Normalized Maximum Transient Thermal Impedance

SOT23-6L Package Information



DIM	MIN	NOM	MAX
A1	0.00	-	0.10
A2	1.00	1.10	1.20
b	0.30	0.40	0.50
c	0.10	0.15	0.20
D	2.80	2.90	3.00
E	1.50	1.60	1.70
E1	2.60	2.80	3.00
e	0.2GAUGE PLANE		
e1	-	1.90	-
L	0.30	0.45	0.60
θ	0°	-	8°
All Dimensions in mm			